

LUNA 35W

LED Surface Mounted Downlight

The Luna 35W LED Downlight is an architectural grade surface mounted downlight ideally suited for challenging environments with ceiling space limitations.

Specifications

System Power	35W
Delivery Lumens	2800 lm
Ingress Protection	IP44
Chip Type	COB
CRI	> 90
Input Voltage	220-240V AC @ 50/60Hz
Lifetime	> 50,000 hours
Tri-Colour Temperatures	3000K Warm White 4000K Cool White 5000K Daylight
Dimmable	Yes
Warranty	3 Years

Temperature to be set during installation process



Dimensions

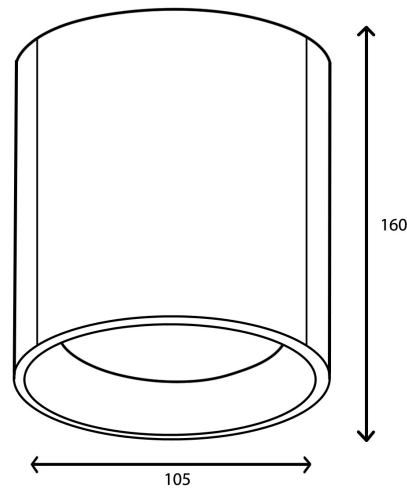

Options & Accessories



White Trim



Black Trim



Gold Trim



3m White
Suspension Kit

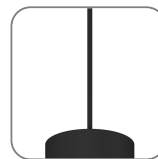

3m Black
Suspension Kit

Order Code

Order Code	Dimming	Finish	Trim Colour	Suspension
LUNA35	<input type="checkbox"/>	<input type="checkbox"/>	<input type="checkbox"/>	<input type="checkbox"/>
	T TRIAC	BK Black	BK Black	SM None
	D DALI	WH White	WH White	BS Black
			GD Gold	WS White



Read more